

40th



International Chemistry Olympiad

**9 theoretical problems
3 practical problems**

THE FORTIETH INTERNATIONAL CHEMISTRY OLYMPIAD 12–21 JULY 2008, BUDAPEST, HUNGARY

THEORETICAL PROBLEMS

PROBLEM 1

The label on a bottle containing a dilute aqueous solution of an acid became damaged. Only its concentration was readable. A *pH* meter was nearby, and a quick measurement showed that the hydrogen ion concentration is equal to the value on the label.

1.1 Give the formulae of four acids that could have been in the solution if the *pH* changed one unit after a tenfold dilution.

1.2 Could it be possible that the dilute solution contained sulfuric acid?

Sulfuric acid: $pK_{a2} = 1.99$

Yes No

If yes, calculate the *pH* (or at least try to estimate it) and show your work.

1.3 Could it be possible that the solution contained acetic acid?

Acetic acid: $pK_a = 4.76$

Yes No

If yes, calculate the *pH* (or at least try to estimate it) and show your work.

1.4 Could it be possible that the solution contained EDTA (ethylene diamino tetraacetic acid)? You may use reasonable approximations.

EDTA: $pK_{a1} = 1.70$, $pK_{a2} = 2.60$, $pK_{a3} = 6.30$, $pK_{a4} = 10.60$

Yes No

If yes, calculate the concentration.

SOLUTION

1.1 Any univalent, strong acid (HCl, HBr, HI, HNO₃, HClO₄) is acceptable. HF is not!

1.2 Yes No

No, the first dissociation step can be regarded as complete in aqueous solutions, thus $[H^+] > c_{\text{acid}}$.

No text or calculations are needed.

1.3 Yes No

Yes, but it can happen only in quite dilute solutions.

$$c = [HA] + [A^-] = [H^+]$$

$$[H^+] = [A^-] + [OH^-]$$

This means that $[HA] = [OH^-]$

$$K = \frac{[H^+][A^-]}{[HA]} = \frac{[H^+]([H^+] - [OH^-])}{[OH^-]} = \frac{[H^+]^3}{K_w} - [H^+]$$

The *pH* of the solution must be acidic, but close to 7.

6.5 is a good guess.

A good approximation is: $[H^+] = \sqrt[3]{(K K_w)}$

The full equation can be solved through iteration: $[H^+] = \sqrt[3]{(K + [H^+])K_w}$

Starting with a neutral solution two cycles of iteration give identical results:

$5.64 \times 10^{-7} \text{ mol dm}^{-3}$ as the required concentration. Exact *pH* is 6.25.

1.4 Yes No

We can suppose that this solution would be quite acidic, so the 3rd and 4th dissociation steps can be disregarded. The following equations are thus true:

$$c = [H_4A] + [H_3A^-] + [H_2A^{2-}] = [H^+]$$

$$[H^+] = [H_3A^-] + 2 [H_2A^{2-}]$$

This means that $[H_4A] = [H_2A^{2-}]$

$$K_1 K_2 = \frac{[H^+]^2 [H_2A^{2-}]}{[H_4A]} = [H^+]^2 \quad (\text{or } pH = (pK_1 + pK_2) / 2 = 2.15)$$

$$c = 0.0071 \text{ mol dm}^{-3}$$

PROBLEM 2

Determine the structure of the compounds **A - H** (stereochemistry is not expected), based on the information given in the following reaction scheme:

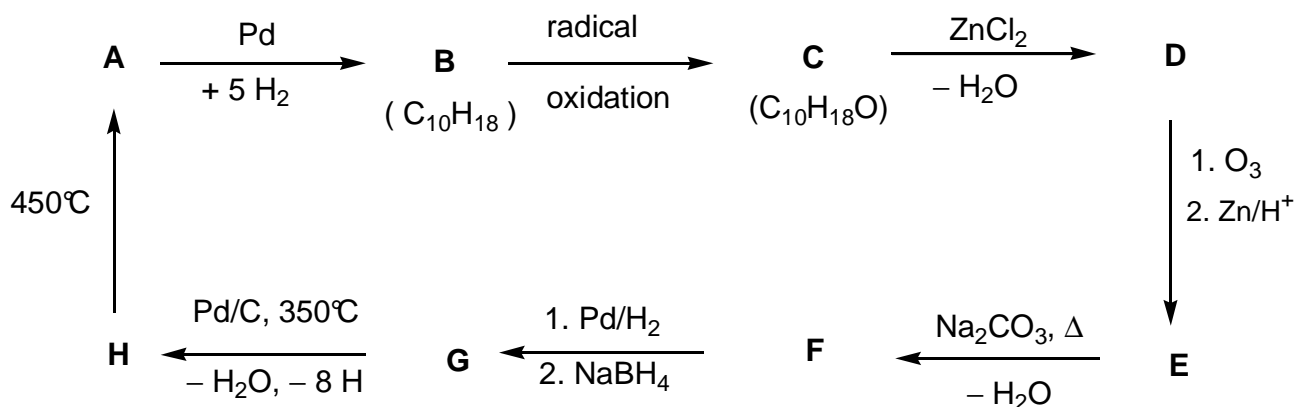

Hints:

- **A** is a well-known aromatic hydrocarbon.
- A hexane solution of **C** reacts with sodium (gas evolution can be observed), but **C** does not react with chromic acid.
- ¹³C NMR spectroscopy shows that **D** and **E** contain only two kinds of CH₂ groups.
- When a solution of **E** is heated with sodium carbonate an unstable intermediate forms at first, which gives **F** on dehydration.

SOLUTION

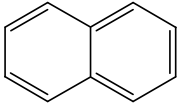
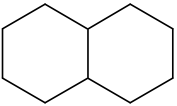
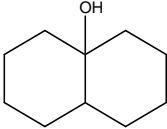
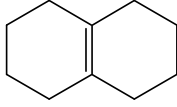
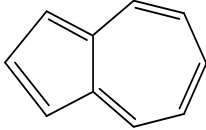
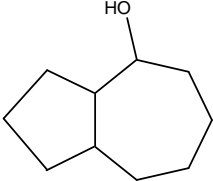
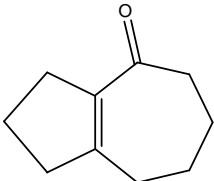
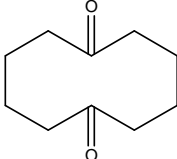
A 	B 	C 	D 
H 	G 	F 	E 

PROBLEM 3

Vinpocetine (Cavinton®, Calan®) is one of the best selling original drugs developed in Hungary. Its preparation relies on a natural precursor, (+)-vincamine (C₂₁H₂₆ N₂O₃), which is isolated from the vine plant, *vinca minor*. The transformation of (+)-vincamine to vinpocetine is achieved in two steps depicted below.

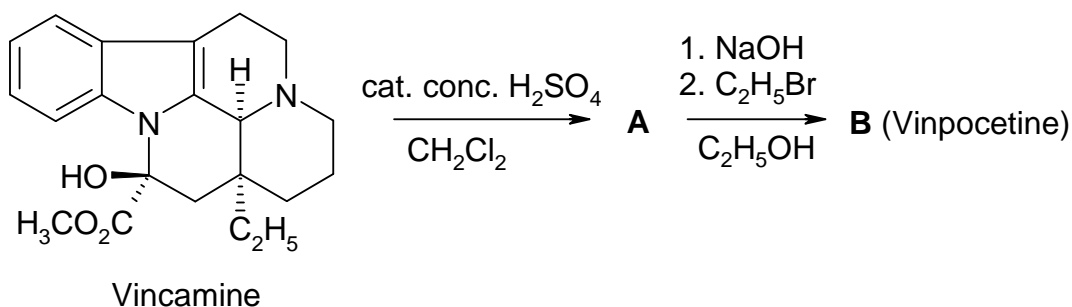

All compounds (**A** to **F**) are enantiomerically pure compounds.

- The elementary composition of **A** is: C 74.97%, H 7.19%, N 8.33%, O 9.55%.
- **B** has 3 other stereoisomers.

3.1 Propose structures for the intermediate **A** and vinpocetine (**B**).

A study of the metabolism of any drug forms a substantial part of its documentation. There are four major metabolites each formed from vinpocetine (**B**): **C** and **D** are formed in hydrolysis or hydration reactions, while **E** and **F** are oxidation products.

Hints:

- The acidity of the metabolites decreases in the order **C** >> **E** >> **D**. **F** does not contain an acidic hydrogen.
- **C** and **E** each have 3 other stereoisomers, while **D** and **F** each have 7 other stereoisomers.
- **F** is a pentacyclic zwitterion and it has the same elementary analysis as **E**: C 72.11 %, H 7.15 %, N 7.64 %, O 13.10 %.
- The formation of **E** from **B** follows an electrophilic pattern.
- The formation of **D** from **B** is both regio- and stereoselective.

3.2 Propose one possible structure for each of the metabolites **C**, **D**, **E** and **F**!

3.3 Draw a resonance structure for **B** that explains the regioselective formation of **D** and the absence of the alternate regioisomer in particular.

SOLUTION

3.1

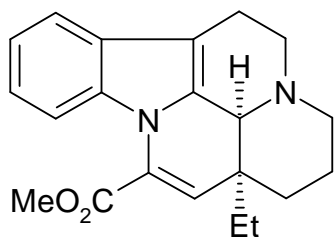

A

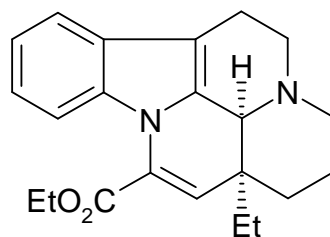

B

3.2

C

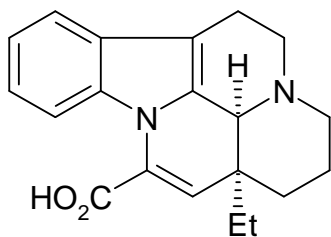

apovincaminic acid

D

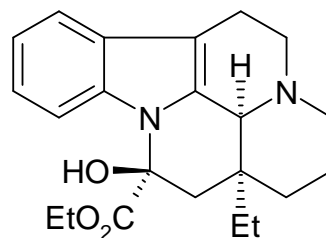

ethyl vincamate

Both stereoisomers around the new chiral center are acceptable.

E

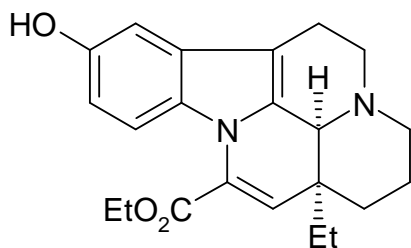

10-hydroxyvinpocetine

F

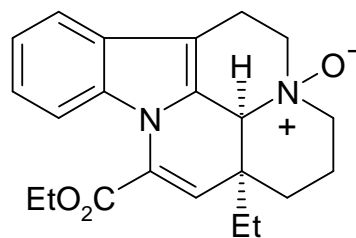

vinpocetine N-oxide

All aromatic positions for the OH are acceptable in **E**.

3.3

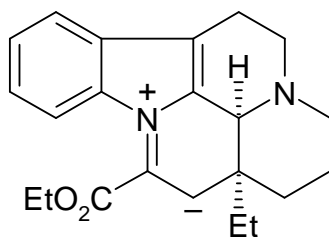

All aromatic positions for the OH are acceptable in **E**.

PROBLEM 4

A major transformation route for oxiranes (epoxides) is ring opening. This may be accomplished in various ways.

On acid catalysis the reactions proceed through cation-like (carbenium ion-like) species. For substituted oxiranes the direction of ring opening (which C–O bond is cleaved) depends on the stability of the intermediate carbenium ion. The more stable the intermediate carbenium ion the more probable its formation. However, an open carbenium ion (with a planar structure) only forms if it is tertiary, benzylic or allylic.

On base catalysis the sterically less hindered C–O bond is cleaved predominantly. Keep stereochemistry in mind throughout the whole problem. To depict stereochemistry use only the \blacktriangleleft \cdots --- bond symbols and nothing else where necessary.

4.1 Draw the structure of the reactant and the predominant products when 2,2-dimethyloxirane (1,2-epoxy-2-methylpropane) reacts with methanol at low temperatures, catalysed by

(i) sulphuric acid

(ii) NaOCH₃.

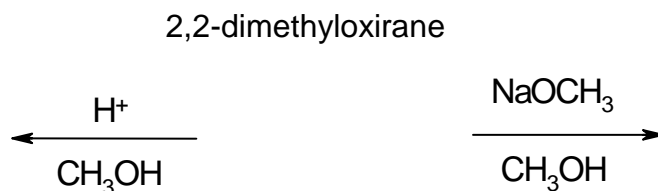

4.2 Draw the structure of the predominant product when the epoxide ring of the following leukotriene derivative is opened with a thiolate (RS[−]).

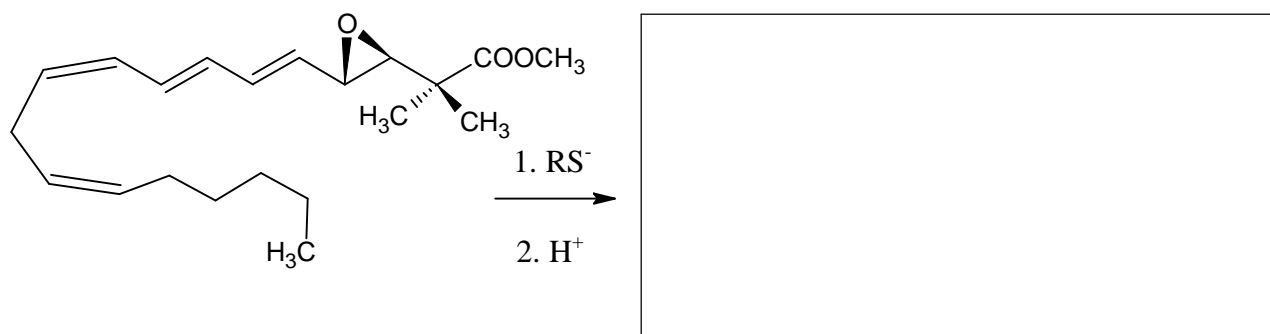

Different porous acidic aluminosilicates can also be used to catalyse the transformation of alkyl oxiranes. In addition to ring opening, cyclic dimerisation is found to be the main reaction pathway producing mainly 1,4-dioxane derivatives (six-membered saturated rings with two oxygen atoms in positions 1,4).

- 4.3** Draw the structure(s) of the most probable 1,4-dioxane derivative(s) when the starting compound is (*S*)-2-methyloxirane ((*S*)-1,2-epoxypropane). Give the structure of the reactant as well.
- 4.4** Draw the structure(s) of the substituted 1,4-dioxane(s) when the epoxide reacting is (*R*)-1,2-epoxy-2-methylbutane ((*R*)-2-ethyl-2-methyloxirane). Give the structure of the reactant as well.
- 4.5** Give the structure(s) of the substituted 1,4-dioxane(s) when this reaction is carried out with racemic 1,2-epoxy-2-methylbutane (2-ethyl-2-methyloxirane).

SOLUTION

4.1

2,2-dimethyloxirane

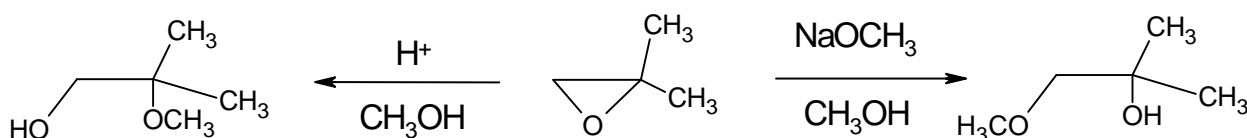

4.2

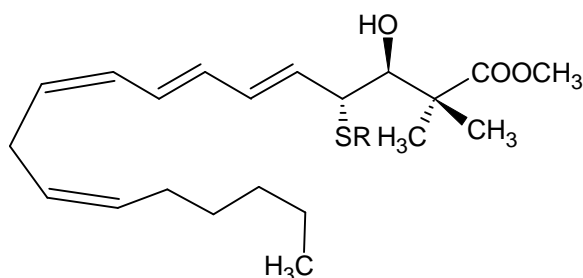

4.3

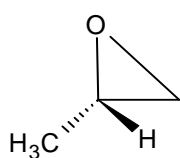

(S)-2-methyloxirane

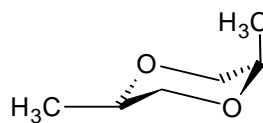

or

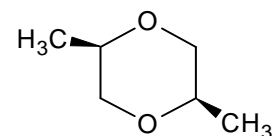

product

4.4 (R)-1,2-epoxy-2-methylbutane:

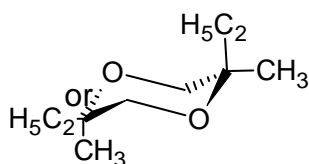
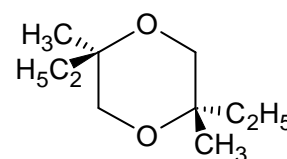
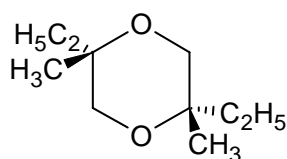
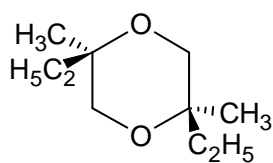
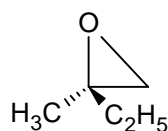

R,R

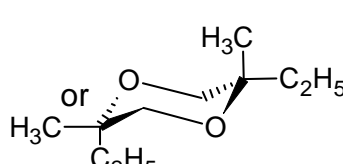

S,S

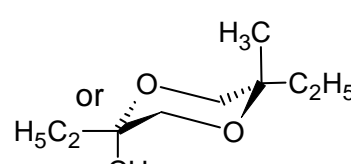

R,S

4.5

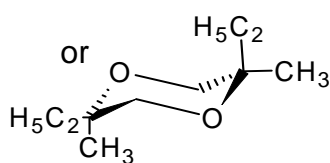
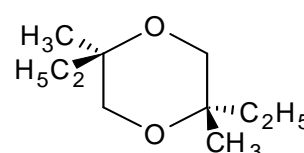
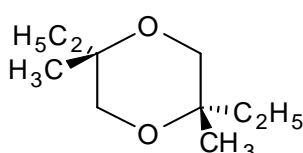
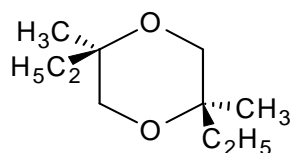

R,R

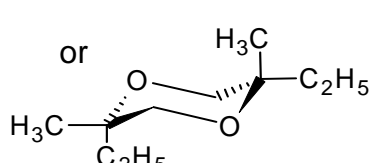

S,S

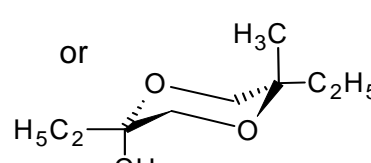

R,S

PROBLEM 5

A and **B** are white crystalline substances. Both are highly soluble in water and can be moderately heated (up to 200 °C) without change but both decompose at higher temperatures. If an aqueous solution of 20.00 g **A** (which is slightly basic, $pH \approx 8.5-9$) is added to an aqueous solution of 11.52 g **B** (which is slightly acidic, $pH \approx 4.5-5$) a white precipitate **C** forms that weighs 20.35 g after filtering, washing and drying. The filtrate is essentially neutral and gives a brown colour reaction with an acidified KI solution. When boiled, the filtrate evaporates without the appearance of any residue.

The white solid **D** can be prepared by the heating of **A** in the absence of air. The exothermic reaction of **D** with water gives a colourless solution. This solution, if kept in an open container, slowly precipitates a white solid **E** and leaves water. Upon prolonged exposure to air at room temperature, solid **D** is transformed into **E** as well. However, heating **D** in air at 500 °C produces a different white substance **F**, which is barely soluble in water and has a mass of only 85.8% of the **E** formed from the same amount of **D**. **F** gives a brown colour reaction with an acidified solution of KI.

E can be converted back into **D** but ignition above 1400 °C is required for this purpose. The reaction of **B** and **D** in water forms the precipitate **C** and is accompanied by a characteristic odour.

5.1 Give the formulae of the substances **A - F**

5.2 Write balanced equations for all the reactions mentioned. (The equation for the thermal decomposition of **B** is not required.)

SOLUTION

5.1 The formulae of the substances **A – F**:

A $Ba(NO_2)_2$	B $(NH_4)_2SO_4$	C $BaSO_4$
D BaO	E $BaCO_3$	F BaO_2

5.2 Equations:

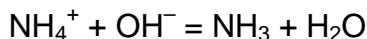
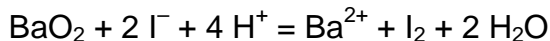
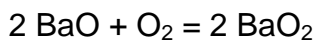
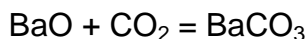
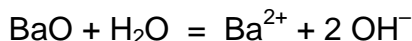
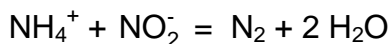
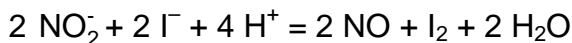
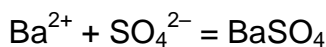

Detailed solution:

The problem contains quite a number of clues to the identification of the compounds. It is clear that **A**, **D**, **E**, and **F** all contain the same element; with a water-soluble solid compound stable at 1400 °C, probably a metal. The aqueous solution of a metal compound giving a precipitate and pure water upon standing in the air strongly hints at the formation of a carbonate, possibly from a soluble hydroxide. A likely conclusion is that **D** is an oxide, limiting the choice of the metal to Sr or Ba. (One might also consider Li, Ca, or Tl which are less satisfactory because $\text{Ca}(\text{OH})_2$ is poorly soluble while the solubilities of Li_2CO_3 and Tl_2CO_3 are quite significant.) If **E** is an alkaline earth metal carbonate, then the molar mass of **F** could be either $M_{\text{Ca}} + 45.8$, or $M_{\text{Sr}} + 39.05$, or $M_{\text{Ba}} + 32$. Since **F** is formed by heating the oxide in air, the former two do not make any sense while the latter is consistent with BaO_2 . This is confirmed by the oxidative capability of **F**.

The odour appearing in the reaction of **B** with $\text{Ba}(\text{OH})_2$ indicates that the former might be an ammonium salt. Assuming that the reaction of **A** and **B** is a simple precipitation between a barium salt and an ammonium salt, we get an equivalent mass of 48 for the anion of the precipitate. This might be either SO_4^{2-} or HPO_4^{2-} but the acidity of **B** is consistent with the former and, in addition, $(\text{NH}_4)_2\text{HPO}_4$ would not

give the same BaHPO_4 precipitate with Ba(OH)_2 as with $\text{Ba(NO}_2)_2$. If we accept that **B** is $(\text{NH}_4)_2\text{SO}_4$, we obtain an equivalent mass of 46 for the anion of **A**. This and the surrounding chemistry are consistent with the nitrite ion.

PROBLEM 6

A feathery, greenish solid precipitate can be observed if chlorine gas is bubbled into water close to its freezing point. Similar precipitates form with other gases such as methane and noble gases. These materials are interesting because vast quantities of the so-called methane-hydrates are supposed to exist in nature (comparable in quantity with other natural gas deposits).

These precipitates all have related structures. The molecules of water just above its freezing point form a hydrogen-bonded structure. The gas molecules stabilize this framework by filling in the rather large cavities in the water structure forming clathrates. The crystals of chlorine and methane clathrates have the same structure. Their main characteristics are dodecahedra formed from 20 water molecules. The unit cell of the crystal can be thought as a body-centered cubic arrangement built from these dodecahedra which are almost spherical objects. The dodecahedra are connected via additional water molecules located on the faces of the unit cell. Two water molecules can be found on each face of the unit cell. The unit cell has an edge dimension of 1.182 nm. There are two types of cavities in this structure. One is the internal space in the dodecahedra (**A**). These are somewhat smaller than the other type of voids (**B**), of which there are 6 for each unit cell.

- 6.1 How many type **A** cavities can be found in a unit cell?
- 6.2 How many water molecules are there in a unit cell?
- 6.3 If all cavities contain a guest molecule, what is the ratio of the number of water to the number of guest molecules?
- 6.4 Methane hydrate is formed with the structure in **c)** at temperatures between 0-10 °C. What is the density of the clathrate?
- 6.5 The density of chlorine hydrate is 1.26 g/cm³. What is the ratio of the number of water and guest molecules in the crystal?
- Which cavities are likely to be filled in a perfect chlorine hydrate crystal? Mark one or more.

Some **A** Some **B** All **A** All **B**

Covalent radii reflect atomic distances when the atoms are covalently bonded. Non-bonded or van der Waals radii give a measure of the atomic size when they are not bonded covalently (modelled as hard spheres).

Atom	Covalent radius (pm)	Nonbonded radius (pm)
H	37	120
C	77	185
O	73	140
Cl	99	180

6.6 Based on the covalent and non-bonded radii of these atoms estimate lower and upper bounds for the average radii of the cavities where possible. Show your reasoning.

Let us consider the following processes

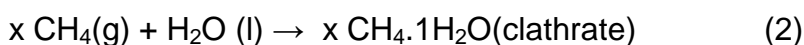

6.7 What are the signs of the following molar quantities referring to these reactions in the given direction at 4 °C? Mark with a -, 0 or +.

	sign
$\Delta G_m(1)$	
$\Delta G_m(2)$	
$\Delta H_m(1)$	
$\Delta H_m(2)$	
$\Delta S_m(1)$	
$\Delta S_m(2)$	
$\Delta S_m(2) - \Delta S_m(1)$	
$\Delta H_m(2) - \Delta H_m(1)$	

SOLUTION

6.1 The number of A cavities in a unit cell: 2

6.2 The number of water molecules in a unit cell?

$$46 = 20 \times 2 \text{ (dodecahedra)} + 6 \times 2 / 2 \text{ (faces)}$$

6.3 The number of water to the number of guest molecules?

$$46 : 8 = 5.75$$

6.4 A unit cell has a volume of $1.182^3 \text{ nm}^3 = 1.651 \text{ nm}^3$.

It contains 8 methane and 46 water molecules with a mass of $957 \text{ g mol}^{-1} / N_A = 1.589 \times 10^{-21} \text{ g}$.

The density is $1.589 / 1.651 = 0.962 \text{ g/cm}^3$.

6.5 The mass of a unit cell with this density is: $1.651 \text{ nm}^3 \times 1.26 \text{ g cm}^{-3} = 2.081 \times 10^{-21} \text{ g}$, meaning 1253 g/mol for the contents.

Subtracting the waters, this means 424.3 g mol^{-1} for the chlorine atoms, giving 11.97 chlorine atoms in a unit cell.

The ratio is then 6 (5.98) chlorine molecules for the 46 waters, or a ratio of 7.68.

It is expected that only the 6 larger B type cavities contain chlorine. Thus:

Some A Some B All A All B

6.6 Methane fits in both cavities, its radius is approximately $37 + 77 + 120 \text{ pm} = 234 \text{ pm}$.

The chlorine molecule, with a radius of $180 + 99 \text{ pm} = 279 \text{ pm}$, fits only in B.

Thus $234 \text{ pm} < r(\text{A}) < 279 \text{ pm}$ and $279 \text{ pm} < r(\text{B})$

6.7

	sign
$\Delta G_m(1)$	+
$\Delta G_m(2)$	-
$\Delta H_m(1)$	-
$\Delta H_m(2)$	-
$\Delta S_m(1)$	-
$\Delta S_m(2)$	-
$\Delta S_m(2) - \Delta S_m(1)$	-
$\Delta H_m(2) - \Delta H_m(1)$	-

Under these conditions, methane clathrate forms, while ice melts to water, so the Gibbs energy changes are of opposite signs.

Freezing is an exothermic process with an entropy decrease in both cases.

The entropy decrease of the clathrate formation is larger in magnitude, as it involves a gas-solid transition.

The relation of the reaction enthalpies can be inferred from these facts:

$$\Delta G_m(1) > \Delta G_m(2)$$

$$\Delta H_m(1) - T \Delta S_m(1) > \Delta H_m(2) - T \Delta S_m(2)$$

$$T (\Delta S_m(2) - \Delta S_m(1)) > \Delta H_m(2) - \Delta H_m(1)$$

$$\text{a negative quantity} > \Delta H_m(2) - \Delta H_m(1)$$

PROBLEM 7

The dithionate ion ($\text{S}_2\text{O}_6^{2-}$) is a rather inert inorganic ion. It can be prepared by bubbling sulphur-dioxide continuously into ice-cooled water to which manganese dioxide is added in small increments. Dithionate and sulphate ions are formed under these circumstances.

7.1 Write the balanced chemical equations for the two reactions.

After the reaction is complete, $\text{Ba}(\text{OH})_2$ is added to the mixture until the sulphate ions are fully precipitated. This is followed by the addition of Na_2CO_3 .

7.2 Write the balanced equation for the reaction that takes place upon addition of Na_2CO_3 .

Sodium dithionate is then crystallized by evaporating some of the solvent. The prepared crystals dissolve readily in water and do not give a precipitate with BaCl_2 solution. When the solid is heated and maintained at 130 °C, 14.88 % weight loss is observed. The resulting white powder dissolves in water and does not give a precipitate with BaCl_2 solution. When another sample of the original crystals is kept at 300 °C for a few hours, 41.34 % weight loss occurs. The resulting white powder dissolves in water and gives a white precipitate with BaCl_2 solution.

7.3 Give the composition of the prepared crystals and write balanced equations for the two processes that occur during heating.

Although dithionate ion is a fairly good reducing agent thermodynamically, it does not react with oxidants in solution at room temperature. At 75 °C, however, it can be oxidized in acidic solutions. A series of kinetic experiments were carried out with bromine as an oxidant.

7.4 Write the balanced chemical equation for the reaction between bromine and dithionate ion.

The initial rates (v_0) of the reaction were determined in a number of experiments at 75 °C.

$[\text{Br}_2]_0$ (mmol dm^{-3})	$[\text{Na}_2\text{S}_2\text{O}_6]_0$ (mol dm^{-3})	$[\text{H}^+]_0$ (mol dm^{-3})	v_0 ($\text{nmol dm}^{-3}\text{s}^{-1}$)
0.500	0.0500	0.500	640
0.500	0.0400	0.500	511
0.500	0.0300	0.500	387
0.500	0.0200	0.500	252
0.500	0.0100	0.500	129
0.400	0.0500	0.500	642
0.300	0.0500	0.500	635
0.200	0.0500	0.500	639
0.100	0.0500	0.500	641
0.500	0.0500	0.400	511
0.500	0.0500	0.300	383
0.500	0.0500	0.200	257
0.500	0.0500	0.100	128

7.5 Determine the order of the reaction with respect to Br_2 , H^+ and $\text{S}_2\text{O}_6^{2-}$, the experimental rate equation, and the value and unit of the rate constant.

In similar experiments, chlorine, bromate ion, hydrogen peroxide and chromate ion have all been used as oxidizing agents at 75 °C. The rate equations for these processes are analogous to the one observed with bromine, the units of all rate constants are the same, the values are 2.53×10^{-5} (Cl_2), 2.60×10^{-5} (BrO_3^-), 2.56×10^{-5} (H_2O_2), and 2.54×10^{-5} ($\text{Cr}_2\text{O}_7^{2-}$).

Experiments were also carried out in acidic sodium dithionate solution without any oxidizing agent. When following the processes by UV spectrophotometry, the slow appearance of a new absorption band around 275 nm was observed. Although hydrogen sulphate ion is a detectable product of the reaction, it does not absorb any light above 200 nm.

7.6 Give the formula of the major species causing the new absorption band and write the balanced equation of the chemical reaction occurring in the absence of oxidants.

An experiment was carried out to follow the absorbance at 275 nm with initial concentrations: $[\text{Na}_2\text{S}_2\text{O}_6] = 0.0022 \text{ mol dm}^{-3}$, $[\text{HClO}_4] = 0.70 \text{ mol dm}^{-3}$, and the temperature was 75 °C. A pseudo first-order kinetic curve was found with a half-life of 10 hours and 45 minutes.

7.7 Calculate the rate constant of the reaction.

Suggest a balanced chemical equation for the rate determining step of the reactions that used an oxidizing agent.

When periodate ion (which is present as H_4IO_6^- in aqueous solution) was used as an oxidant for dithionate ion, the two kinetic curves depicted in the graph were detected at 75 °C in the same experiment at two different wavel engths. The initial concentrations were $[\text{H}_4\text{IO}_6^-] = 5.3 \cdot 10^{-4} \text{ mol dm}^{-3}$, $[\text{Na}_2\text{S}_2\text{O}_6] = 0.0519 \text{ mol dm}^{-3}$, $[\text{HClO}_4] = 0.728 \text{ mol dm}^{-3}$. At 465 nm, only I_2 absorbs and its molar absorption coefficient is $715 \text{ dm}^3 \text{ mol}^{-1} \text{ cm}^{-1}$. At 350 nm, only I_3^- absorbs and its molar absorption coefficient is $11000 \text{ dm}^3 \text{ mol}^{-1} \text{ cm}^{-1}$. The optical path length was 0.874 cm.

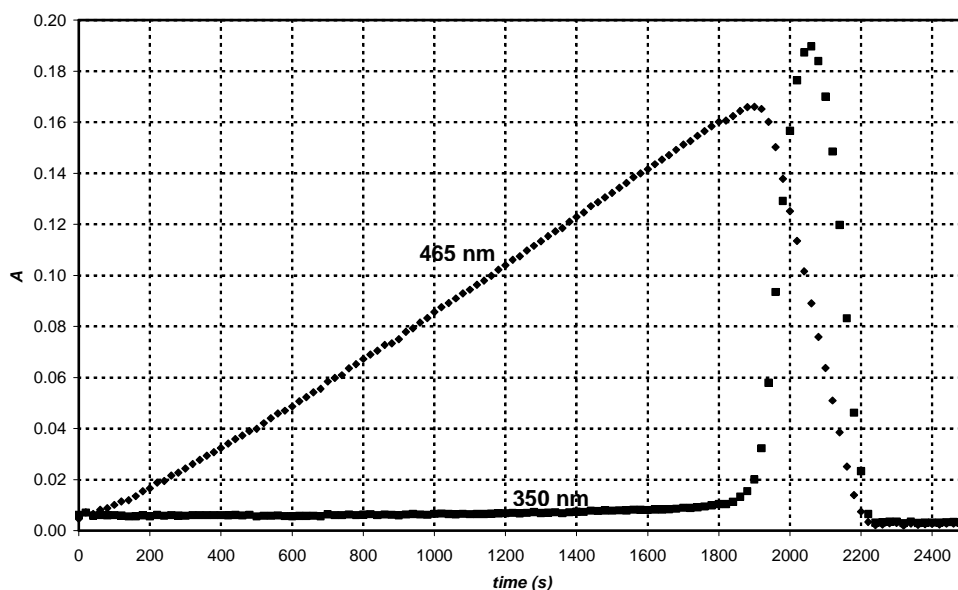

7.8 Write balanced chemical equations for the reactions that occur in the region where the absorbance increases at 465 nm, and in the region where the absorbance decreases at 465 nm.

Calculate the expected time for the maximum absorbance of the kinetic curve measured at 465 nm.

Estimate the expected ratio of the slopes of the increasing and decreasing regions in the kinetic curve measured at 465 nm.

SOLUTION

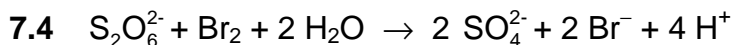
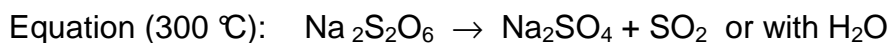
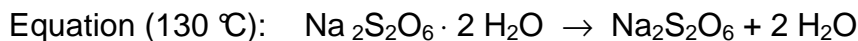
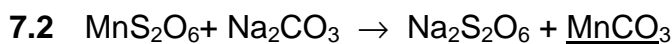
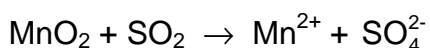
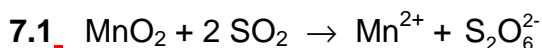

$$k = 2.56 \cdot 10^{-5} \text{ dm}^3 \text{ mol}^{-1} \text{ s}^{-1}$$

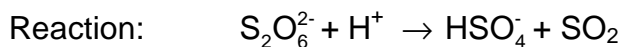

7.7 $t_{1/2} = 10 \text{ h } 45 \text{ min} = 3.87 \cdot 10^4 \text{ s}$

$$k_{\text{obs}} = \ln 2 / t_{1/2} = 1.79 \times 10^{-5} \text{ s}^{-1}$$

$$k = k_{\text{obs}} / [\text{H}^+] = 2.56 \times 10^{-5} \text{ dm}^3 \text{ mol}^{-1} \text{ s}^{-1}$$

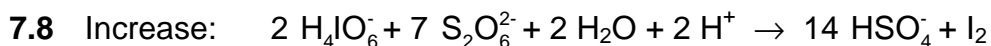
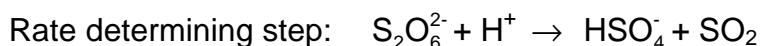

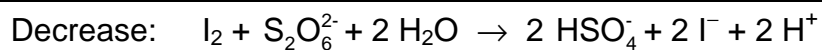

The expected time for the maximum absorbance of the kinetic curve measured at 465 nm:

$$t_{\max} = \frac{7}{2} \frac{[\text{H}_4\text{IO}_6^-]_0}{k[\text{S}_2\text{O}_6^{2-}]_0[\text{H}^+]_0} = \frac{7 \times 5.3 \times 10^{-4} \text{ M}}{2 \times 2.56 \times 10^{-5} \text{ M}^{-1}\text{s}^{-1} \times 0.0519 \text{ M} \times 0.728 \text{ M}} = 1900 \text{ s}$$

The expected ratio of the slopes of the increasing and decreasing regions in the kinetic curve measured at 465 nm: 1; -7 (it reflects the stoichiometry).

PROBLEM 8

Ms. Z was a bright student, whose research project was to measure the complexation of all lanthanide(III) ions with newly designed complexing ligands. One day she monitored the UV-VIS absorption with Ce(III) and a particularly poor complexing ligand in a spectrophotometer. She noticed that some small bubbles had formed in the closed cell by the end of the 12-hour experiment. Soon she realized that the presence of the ligand is not necessary to see the bubble formation, and continued her experiments with an acidified CeCl₃ solution. Bubble formation never occurred when she just kept the solution in the spectrophotometer without turning on the instrument. Next, Ms. Z used a small quartz flask, in which she dipped a chloride ion selective electrode and could also withdraw samples regularly for spectrophotometric measurements. She calibrated the chloride ion selective electrode using two different NaCl solutions and obtained the following results:

c_{NaCl} (mol/dm ³)	E (mV)
0.1000	26.9
1.000	-32.2

8.1 Give a formula to calculate the chloride ion concentration of an unknown sample based on the electrode voltage reading (E).

Ms. Z also determined the molar absorption coefficient for Ce³⁺ ($\epsilon = 35.2 \text{ dm}^3 \text{ mol}^{-1} \text{ cm}^{-1}$) at 295 nm, and, as a precaution, also for Ce⁴⁺ ($\epsilon = 3967 \text{ dm}^3 \text{ mol}^{-1} \text{ cm}^{-1}$).

8.2 Give a formula to calculate the Ce³⁺ concentration from an absorbance reading at 295 nm (A) measured in a solution containing CeCl₃ (cuvette path length: 1.000 cm).

Ms. Z prepared a solution which contained 0.0100 mol/dm³ CeCl₃ and 0.1050 mol/dm³ HCl, and began her experiment by turning on a quartz lamp. HCl does not absorb at 295 nm.

8.3 What were the expected initial absorbance ($A_{295\text{nm}}$) and voltage (E) readings?

Before the quantitative experiment Ms. Z collected the gas formed into a carefully neutralized solution of methyl orange (acid-base and redox indicator). Although she saw bubbles going through the solution, the colour did not change or fade even after a day.

8.4 Give the formula of two gases, comprised of elements in the illuminated sample, which could not be present given the results of this experiment.

During her quantitative experiment she recorded the absorbance and voltage values regularly. The uncertainty of the spectrophotometric measurements is ± 0.002 and the accuracy of the voltage measurements is ± 0.3 mV.

time (min)	0	120	240	360	480
$A_{295\text{ nm}}$	0.349	0.348	0.350	0.348	0.349
	6	8	4	9	9
E (mV)	19.0	18.8	18.8	19.1	19.2

8.5 Estimate the average rate of change in the concentrations of Ce^{3+} , Cl^- , and H^+ .
 $d[\text{Ce}^{3+}]/dt = d[\text{Cl}^-]/dt = d[\text{H}^+]/dt = ?$

The following day, Ms. Z used an intense monochromatic light beam (254 nm) with an intensity of 0.0500 W. She passed this light through a 5-cm long quartz photoreactor filled with the same acidic CeCl_3 solution she had used before. She measured the molar absorption coefficient for Ce^{3+} ($\epsilon = 2400 \text{ dm}^3 \text{ mol}^{-1} \text{ cm}^{-1}$) at 254 nm.

8.6 What percentage of the light is absorbed in this experimental setup?

The equipment allowed her to lead the gas first through a drying tube that removed traces of water vapour and then into a closed chamber, whose volume was 68 cm^3 . The chamber was equipped with a high-precision manometer and an igniter. She first filled the chamber with dry argon to a pressure of 102165 Pa and then she turned on the lamp. In 18.00 hours, the pressure reached 114075 Pa. The temperature of the equipment was $22.0 \text{ }^\circ\text{C}$.

8.7 Estimate the amount of substance of the gas collected in the chamber.

At this point, Ms. Z turned off the light and pressed the ignition button. When the chamber cooled down to the initial temperature, the final pressure was 104740 Pa.

- 8.8 Suggest the formula(s) of the gas(es) formed and collected, and give the balanced equation for the original chemical reaction taking place under illumination.
- 8.9 What would be the final pressure after the ignition if the chamber was being filled for 24 hours before ignition?
- 8.10 Estimate the quantum yield of product formation in the Ce(III) solution.

SOLUTION

$$8.1 \quad [\text{Cl}^-] = 10^{-(E+32.2\text{mV})/59.1\text{mV}}$$

$$8.2 \quad [\text{Ce}^{3+}] = \frac{A_{295\text{nm}}}{35.2\text{dm}^3\text{mol}^{-1}}$$

$$8.3 \quad [\text{Ce}^{3+}] = 0.0100\text{ mol/dm}^3 \Rightarrow A_{295\text{nm}} = 0.352$$

$$[\text{Cl}^-] = 3 \cdot 0.0100\text{ mol/dm}^3 + 0.1050\text{ mol/dm}^3 = 0.1350\text{ mol/dm}^3 \Rightarrow E = 19.2\text{ mV}$$

8.4 HCl, Cl₂, (O₃, ClO₂) (no oxidation of indicator)

$$8.5 \quad d[\text{Ce}^{3+}]/dt = ? \quad d[\text{Cl}^-]/dt = ? \quad d[\text{H}^+]/dt = ?$$

No significant change in either Cl⁻ or Ce³⁺ concentrations.

$$[\text{H}^+] = [\text{Cl}^-] - 3[\text{Ce}^{3+}], \text{ no significant change.}$$

All three values are zero.

8.6 What percentage of the light is absorbed in this experimental setup?

$$A = 2400\text{ dm}^3\text{ mol}^{-1}\text{ cm}^{-1} \times 5\text{ cm} \times 0.0100\text{ M} = 120 \Rightarrow (100 - 10^{-118})\% \approx 100\%$$

$$8.7 \quad p_{\text{partial}} = p_{\text{final}} - p_{\text{initial}} = 114075\text{ Pa} - 102165\text{ Pa} = 11910\text{ Pa}$$

$$n = p_{\text{partial}} V / (RT) = 11910\text{ Pa} \cdot 0.000068\text{ m}^3 / (8.314\text{ J mol}^{-1}\text{ K} \times 295.15\text{ K}) =$$

$$= 3.3 \times 10^{-4}\text{ mol}$$

identity of gases: H₂, O₂

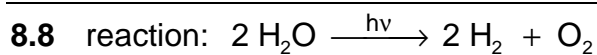

8.9 Final pressure: 104740 Pa (saturated water vapour)

8.10 Quantum yield:

3.3×10^{-4} mol gas formed altogether: 2.2×10^{-4} mol H_2 and 1.1×10^{-4} mol O_2 .

$$\text{Light beam intensity } 0.0500 \text{ J s}^{-1} \Rightarrow \frac{0.0500 \text{ J s}^{-1} \lambda}{h c N_A} = 1.06 \times 10^{-7} \text{ mol s}^{-1} \text{ photon}$$

Total time 18.00 h = 64800 s

Total number of absorbed photons: $64800 \text{ s} \times 1.06 \times 10^{-7} \text{ mol s}^{-1} = 6.87 \times 10^{-3} \text{ mol}$

Quantum yield for H_2 production: $\Phi = 2.2 \times 10^{-4} \text{ mol} / 6.87 \times 10^{-3} \text{ mol} = 0.032$

Quantum yield for O_2 production: $\Phi = 1.1 \times 10^{-4} \text{ mol} / 6.87 \times 10^{-3} \text{ mol} = 0.016$

Either value or the quantum yield of the gas production (0.048) is acceptable when demonstrated in a calculation.

PROBLEM 9

Thallium exists in two different oxidation states: Tl^+ and Tl^{3+} . Iodide ions can combine with iodine to form tri-iodide ions (I_3^-) in aqueous solutions,

The standard redox potentials for some relevant reactions are:

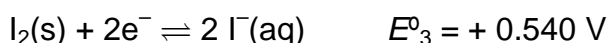
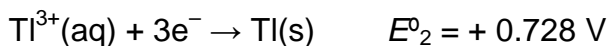

The equilibrium constant for the reaction $I_2(s) + I^-(aq) \rightarrow I_3^-(aq)$: $K_1 = 0.459$.

Use $T=25 \text{ }^\circ\text{C}$ throughout this problem.

9.1 Calculate the redox potentials E^0_4 and E^0_5 for the following reactions:

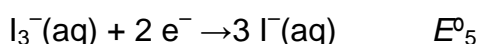
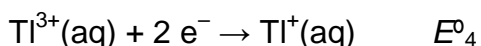

9.2 Write empirical formulae for all theoretically possible neutral compounds that contain one thallium ion and any number of iodide and/or tri-iodide ion(s) as anion(s).

There is an empirical formula that could belong to two different compounds. Which one? Based on the standard redox potentials, which of the two isomers mentioned above is the stable one at standard conditions? Write the chemical reaction for the isomerisation of the other isomer of thallium iodide.

Complex formation can shift this equilibrium. The cumulative complex formation constant for the reaction $Tl^{3+} + 4I^- \rightarrow TlI_4^-$ is $\beta_4 = 10^{35.7}$

9.3 Write the reaction that takes place when a solution of the more stable isomer of thallium iodide is treated with an excess of KI. Calculate the equilibrium constant K_2 for this reaction.

If the solution of the more stable isomer is treated with a strong basic reagent precipitation of a black substance can be observed. After the water content of the precipitate is removed, the remaining material contains 89.5% thallium (by mass).

9.4 What is the empirical formula of this compound? Show your calculations. Write a balanced equation for its formation.

SOLUTION

$$9.1 \quad E_4^0 = \frac{3E_2^0 - E_1^0}{2} = 1.26 \text{ V}$$

$$E_5^0 = E_3^0 + 0.059 / 2 \log(1 / K_1) = 0.550 \text{ V}$$

9.2 Tl I, Tl I₃, Tl I₅, Tl I₇, Tl I₉

Tl I₃ can be either Tl³⁺(I⁻)₃ or Tl⁺(I₃⁻)

More stable: Tl⁺(I₃⁻)

as $E_4^0 > E_5^0$ or E_3^0 ,

Isomerisation: Tl³⁺ + 3 I⁻ = Tl⁺ + I₃⁻

9.3 Reaction: Tl⁺ + I₃⁻ + I⁻ → Tl I₄⁻

This reaction could be regarded as sum of three reactions:

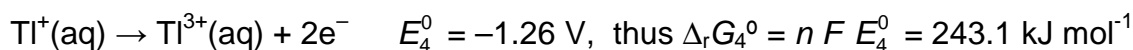

The net free enthalpy change is $\Delta_r G_7^0 = \Delta_r G_4^0 + \Delta_r G_5^0 + \Delta_r G_6^0 = -66.8 \text{ kJ mol}^{-1}$

$$\text{Thus } K_2 = \exp\left(-\frac{\Delta_r G_7^0}{RT}\right) = 4.96 \cdot 10^{11}$$

9.4 Supposing that the substance contains Tl and an anion, the formula of the compound is Tl_aX_b and the following equation holds:

$$\frac{a \cdot 204.4}{a \cdot 204.4 + bM_X} = 0.895$$

From the values $b = 1, 3$ and $a = 1, 2, 3$ only $b = 3, a = 2$ gives a realistic:

$$M_X = 16.0 \text{ g mol}^{-1}.$$

X is oxygen.

Formula: Tl₂O₃.

Equation: 2 Tl I₃ + 6 OH⁻ → Tl₂O₃ + 6 I⁻ + 3 H₂O

PRACTICAL PROBLEMS

PROBLEM 1 (Practical)

Synthesis of α -D-glucopyranose pentaacetate

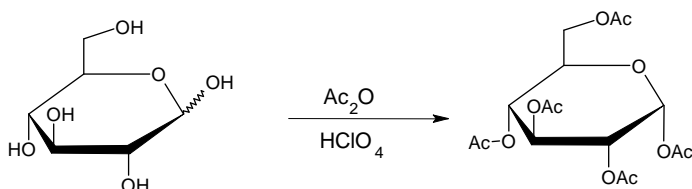

Caution: Use gloves while manipulating acetic acid and acetic anhydride. Let the lab supervisors know if any is spilled.

Add and mix 12 cm³ of pure acetic acid to 12 cm³ of acetic anhydride (provided in an Erlenmeyer flask) and add 3.00 g glucose (acetic anhydride is in excess). Add with a Pasteur-pipette 5 drops of 30% HClO₄ dissolved in acetic acid. After the addition of the catalyst the solution might warm up considerably.

Let the mixture rest covered for 10 minutes and swirl it from time to time. Pour the reaction mixture into 100 cm³ of water in a beaker. Scratch the wall of the beaker with a glass rod to initiate crystallization, and let it crystallize for 10 minutes. Filter and wash the product two times with 10 cm³ of water using the syringe and the porous polypropylene filter disc.

Filtration using a plastic syringe

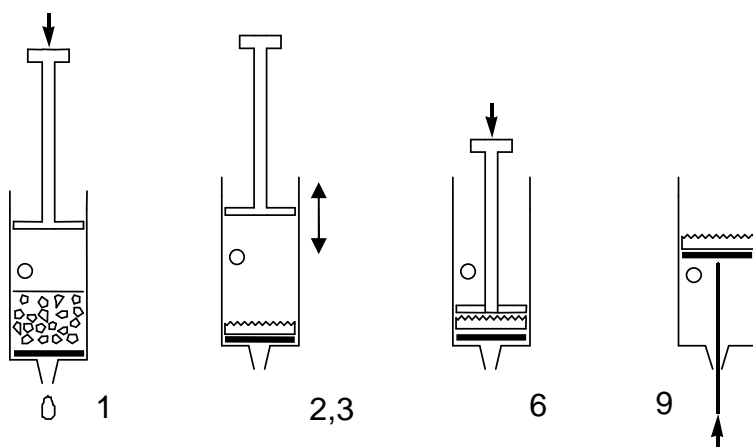

1. Pull out the piston. Fill the syringe from above with the suspension to be filtered. The syringe can be filled to the level of the hole. Replace piston.
2. Cover the hole with your finger and press in the piston as far as the hole.
3. Open the hole and draw the piston back. Do not draw in air through the filter.
4. Repeat steps 2-3 a few times to expel the liquid.
5. Repeat steps 1-4 until all solids are on the filter.
6. Press the piston against the filter cake and squeeze out the liquid.
7. Wash the product twice with 10 cm³ of water repeating steps 1-4.
8. Press the piston against the filter cake and squeeze out the water.
9. Pull the piston out with the hole closed to lift out the filter cake. (Pushing with the end of the spatula can help.)

1.1 Place your product in the open Petri dish marked with your code. Leave it on your table. The organizers will dry it, weigh it and check it for purity.

1.2 Calculate the theoretical yield (mass) of your product in g. ($M(C) = 12 \text{ g mol}^{-1}$, $M(O) = 16 \text{ g mol}^{-1}$, $M(H) = 1.0 \text{ g mol}^{-1}$)

Synthesis of α -D-glucopyranose pentaacetate from β -D-glucopyranose pentaacetate

An alternative synthesis of α -D-glucopyranose pentaacetate starts from readily available β -D-glucopyranose pentaacetate. In this experiment we will study the kinetics of this reaction with thin layer chromatography.

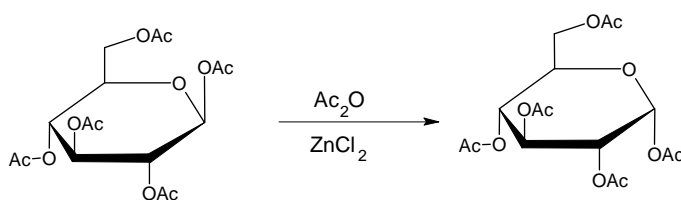

Add 1.5 cm³ acetic anhydride to 50 mg of anhydrous ZnCl₂ (preweighed in a test tube). Add 100 mg of pure β -D-glucopyranose pentaacetate (BPAG) and swirl until dissolved. Take three drops from this mixture into an Eppendorf tube, add 0.5 cm³ methanol and save it.

Place the test tube in the heating apparatus under the hood closest to your desk. Place the test tube in the heating block preadjusted to 70°C. Mix the contents of the test tube from time to time. During the reaction take three drops of sample from the mixture

with a Pasteur pipet after 2, 5, 10, and 30 minutes. Mix immediately each sample with 0.5 cm³ of methanol to stop the reaction in an Eppendorf tube.

Prepare a silica TLC plate with the collected samples to study the reaction kinetics. Apply the necessary reference compounds as well to help identification of the spots on the plate. Mark the spots with a pencil, and develop the plate in isobutyl acetate/ isoamyl acetate (1:1) eluent. Heat the plates with a heat-gun (under the hood!) to visualise the spots (the colour is stable). You can ask for a second plate without penalty points if needed for proper evaluation.

1.3 Copy your plate on the answer sheet and place your plate in the labelled zip lock bag.

1.4 Interpret your experiment and choose the correct answer.

The acetylation reaction of glucose is exothermic.

- a) Yes
- b) No
- c) Cannot be decided based on these experiments

The isomerisation reaction of β -D-glucopyranose pentaacetate can be used for the preparation of pure α -D-glucopyranose pentaacetate.

- a) Yes
 - b) No
 - c) Cannot be decided based on these experiments
-

SOLUTION

1.1 Yield of the product in g, measured by the organizer.

The samples are dried by the organisers. The typical yield is 70 %.

Purity is checked by solubility (acetone) and TLC. If there is no insoluble material and no impurity is detectable by TLC, the full points for the yield are received.

1.1 Calculation of the theoretical yield of the product in g:

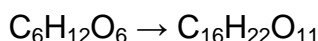

$$m = \frac{3.00 \text{ g} \times 390 \text{ g mol}^{-1}}{180 \text{ g mol}^{-1}} = 6.50 \text{ g}$$

1.3 The developed TLC plate was expected to be sketched on the answer sheet.

Full points were given if both standards and all samples are present.

1.4 Solutions: a), a).

PROBLEM 2 (Practical)

When potassium hexacyanoferrate(II), $K_4[Fe(CN)_6]$ is added to a solution containing zinc ions, an insoluble precipitate forms immediately. Your task is to find out the composition of the stoichiometric precipitate that contains no water of crystallization.

The precipitation reaction is quantitative and so quick that it can be used in a titration. The end point can be detected using redox indication, but first the concentration of the potassium hexacyanoferrate(II) solution has to be determined.

Preparation of $K_4[Fe(CN)_6]$ solution and determination of its exact concentration

Dissolve the solid $K_4[Fe(CN)_6] \cdot 3H_2O$ ($M = 422.41$ g/mol) sample in the small Erlenmeyer flask and quantitatively transfer it into the 100.00 cm³ volumetric flask. Take 10.00 cm³ portions of the hexacyanoferrate(II) solution. Add 20 cm³ 1 mol/dm³ sulfuric acid and two drops of the ferroin indicator solution to each sample before titration. Titrate with the 0.05136 mol/dm³ Ce^{4+} solution. Repeat titration as necessary. Cerium(IV) is a strong oxidant under acidic conditions forming Ce(III).

2.1 Report the Ce^{4+} solution volumes consumed.

2.2 Give the equation for the titration reaction. What was the mass of your $K_4[Fe(CN)_6] \cdot 3H_2O$ sample?

The reaction between zinc ions and potassium hexacyanoferrate(II)

Take 10.00 cm³ of the hexacyanoferrate(II) solution and add 20 cm³ 1 mol/dm³ sulfuric acid. Add three drops of indicator solution (diphenyl amine) and two drops of $K_3[Fe(CN)_6]$ solution. The indicator only works if the sample contains some hexacyanoferrate(III), $[Fe(CN)_6]^{3-}$. Titrate slowly with the zinc solution. Continue until a bluish violet colour appears. Repeat titration as necessary.

2.3 Report the zinc solution volumes consumed.

2.4 Interpret the titration answering the questions on the answer sheet.

Mark the correct answer:

The diphenyl amine indicator changes in colour at the end point

- a) because the concentration of the Zn^{2+} ions increases.
- b) because the concentration of the $[Fe(CN)_6]^{4-}$ ions decreases.
- c) because the concentration of the $[Fe(CN)_6]^{3-}$ ions increases.
- d) because the indicator is liberated from its complex.

Which form of the indicator is present before the end point?

- a) Oxidized
 b) Reduced
 c) Complexed to a metal ion

At the beginning of the titration the redox potential for the hexacyanoferrate(II) - hexacyanoferrate(III) system is lower than the redox potential of the diphenyl amine indicator.

- a) True
 b) False

2.5 Determine the formula of the precipitate.

SOLUTION

2.1 Ce^{4+} consumptions:

Full marks if V_1 is within 0.15 cm^3 of the expected value recalculated from the $\text{K}_4[\text{Fe}(\text{CN})_6]$ mass. Zero marks if deviation is more than 0.50 cm^3 . Linear scale is applied in between.

2.2 The titration reaction:

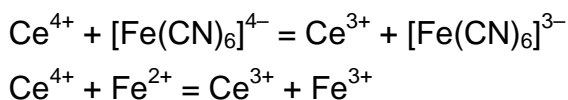

2.3 Zinc consumptions:

Full marks (25 pts.) if V_2 is within 0.15 cm^3 of the expected value recalculated from $\text{K}_4[\text{Fe}(\text{CN})_6]$ mass, zinc concentrations and empirical ratio. Zero marks if the deviation is more than 0.50 cm^3 . Linear scale is applied in between.

2.4 Solutions: b), b), a)

2.5 Determine the formula of the precipitate. Show your work.

The mole ratio of the zinc : hexacyanoferrate(II) in the precipitate can be evaluated as:

$$\frac{n(\text{Zn})}{n(\text{Fe}(\text{CN})_6)} = \frac{10 c(\text{Zn}) V_2 M}{m}$$

Values for $c(\text{Zn})$ are distributed according to a certain plan.

The empirical ratio obtained from the experiments is 1.489.

Calculating the zinc/hexacyanoferrate(II) ratio:

Cations are needed to make the precipitate neutral and only potassium is present.

The precipitate is $\text{K}_2\text{Zn}_3[\text{Fe}(\text{CN})_6]_2$.

Any other reasonable calculation giving the same result is accepted.

Hydrogen instead of potassium ($\text{H}_2\text{Zn}_3[\text{Fe}(\text{CN})_6]_2$ or $\text{KHZn}_3[\text{Fe}(\text{CN})_6]_2$) is also acceptable.

PROBLEM 3 (Practical)

Caution:

Handle all unknown solutions as if they were toxic and corrosive. Discard them only in the appropriate waste container.

The heat gun heats the expelled air up to 500 °C. Do not direct the stream towards combustible materials or body parts. Be careful with the hot nozzle.

Always place a single piece of pumice into liquids before heating to avoid bumping. Never point the mouth of a heated test tube towards a person.

You have eight unknown aqueous solutions. Each solution contains only one compound. The same ion may appear in more than one solution. Every compound formally consists of one type of cation and one type of anion from the following list:

Cations: H^+ , NH_4^+ , Li^+ , Na^+ , Mg^{2+} , Al^{3+} , K^+ , Ca^{2+} , Cr^{3+} , Mn^{2+} , Fe^{2+} , Fe^{3+} , Co^{2+} , Ni^{2+} , Cu^{2+} , Zn^{2+} , Sr^{2+} , Ag^+ , Sn^{2+} , Sn^{4+} , Sb^{3+} , Ba^{2+} , Pb^{2+} , Bi^{3+}

Anions: OH^- , CO_3^{2-} , HCO_3^- , CH_3COO^- , $\text{C}_2\text{O}_4^{2-}$, NO_2^- , NO_3^- , F^- , HPO_4^{2-} , H_2PO_4^- , SO_4^{2-} , HSO_4^- , S^{2-} , HS^- , Cl^- , ClO_4^- , MnO_4^- , Br^- , I^-

You have test tubes and heating at your disposal but no additional reagents apart from distilled water and *pH* paper.

Identify the compounds in the solutions **1-8**. You can use the solubility table for some of the anions on the next page. If you are unable to identify an ion exactly, give the narrowest selection possible.

Remarks: The unknown solutions may contain minor impurities arising from their exposure to air. The concentration of all solutions is around 5 % by mass so you can expect clearly observable precipitates from the main components. In some cases, precipitation does not occur instantaneously; some substances may remain in an oversaturated solution for a while. Don't draw negative conclusions too hastily, wait 1-2 minutes where necessary. Always look carefully for all signs of a reaction.

Keep in mind that heating accelerates all processes, increases the solubility of most substances, and may start reactions that do not take place at room temperature.

SOLUTION

The solutions received by the students contain the following compounds in eight test-tubes: AgNO_3 , BaI_2 , KHCO_3 , MgSO_4 , NaHS , NaOH , NH_4ClO_4 , $\text{Pb}(\text{CH}_3\text{COO})_2$ ($\text{Pb}(\text{OAc})_2$). There were eight sets of samples differing in order of the compounds in particular test tubes.

The problem can be approached in many ways. A systematic solution is given here for one of the sets of test tubes with the following order of the compounds:

Test tube No	1	2	3	4	5	6	7	8
Compound	AgNO_3	KHCO_3	NH_4ClO_4	NaOH	NaHS	$\text{Pb}(\text{OAc})_2$	BaI_2	MgSO_4

All solutions are colourless (NaHS may be slightly yellowish because of polysulfide impurity). Solutions **1**, **3**, **6**, **7**, and **8** are practically neutral (pH paper reading about 5-6). Solution **2** is basic ($\text{pH} = 9$) while solutions **4** and **5** are very strongly basic ($\text{pH} > 11$).

We can exclude all ions that only form coloured compounds in aqueous solutions: Cr^{3+} , Fe^{2+} , Fe^{3+} , Co^{2+} , Ni^{2+} , Cu^{2+} , and MnO_4^- . (In principle we should also exclude Mn^{2+} but its solutions have a very light pink colour that might be mistaken for colourless. The yellowish solution is strongly basic hence its colour cannot be attributed to iron.) The compounds of H^+ , Sn^{2+} , Sn^{4+} , Sb^{3+} , Bi^{3+} , and HSO_4^- with the possible counter-ions could only exist in markedly acidic solutions; therefore they can also be safely excluded.

Thus the list of possible ions is:

Cations: NH_4^+ , Li^+ , Na^+ , Mg^{2+} , Al^{3+} , K^+ , Ca^{2+} , Mn^{2+} , Zn^{2+} , Sr^{2+} , Ag^+ , Ba^{2+} , Pb^{2+} .

Anions: OH^- , CO_3^{2-} , HCO_3^- , CH_3COO^- , $\text{C}_2\text{O}_4^{2-}$, NO_2^- , NO_3^- , F^- , PO_4^{3-} , HPO_4^{2-} , H_2PO_4^- , SO_4^{2-} , S^{2-} , HS^- , Cl^- , ClO_4^- , Br^- , I^- .

The unknown solutions react with each other as follows (\downarrow = precipitate; \uparrow = volatile product; "no change" means even when boiled, unless indicated otherwise):

	1	2	3	4	5	6	7	8
	AgNO ₃	KHCO ₃	NH ₄ ClO ₄	NaOH	NaHS	Pb(OAc) ₂	BaI ₂	MgSO ₄
1 AgNO ₃	—	—	—	—	—	—	—	—
2 KHCO ₃	↓ light yellow ↑ neutral, odourless	—	—	—	—	—	—	—
3 NH ₄ ClO ₄	no change	↓ white crystals (*)	—	—	—	—	—	—
4 NaOH	↓ brown-black	no change	boiling: ↑ basic, odour of ammonia	—	—	—	—	—
5 NaHS	↓ black solution turns acidic	no change	boiling: ↑ basic, odour of NH ₃ , H ₂ S	no change	—	—	—	—
6 Pb(OAc) ₂	↓ white crystals	↓ white ↑ neutral, odourless	no change	↓ white	↓ black	—	—	—
7 BaI ₂	↓ yellow	↓ white ↑ (**)	no change	no change	no change	↓ yellow	—	—
8 MgSO ₄	↓ white crystals	no change (***)	no change	↓ white	no change (****)	↓ white	↓ white	—

(*): upon boiling, the formation of NH₃ is detectable by its odour and by *pH* paper.

(**): gas bubbles are usually not observed when **2** is in excess.

(***): upon boiling, an odourless gas evolves and a white precipitate forms.

(****): upon boiling, a white precipitate forms and the odour of H₂S appears.

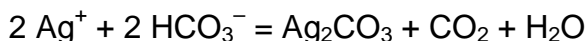

$\text{Mg}^{2+} + 2 \text{HCO}_3^- = \text{MgCO}_3 + \text{CO}_2 + \text{H}_2\text{O}$ (more accurately, basic carbonates of variable composition are formed)

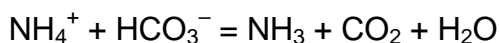
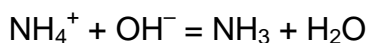
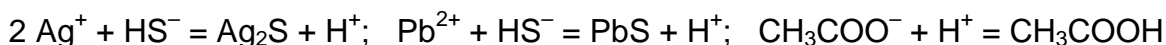
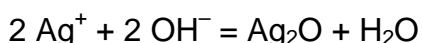
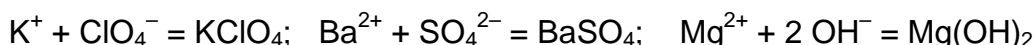
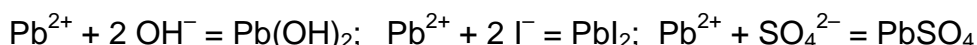
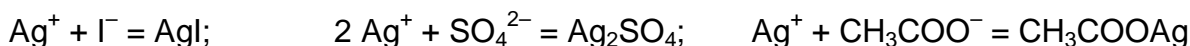

Two groups of the observed phenomena give instant clues to the identification of some of the ions.

First, the reactions of **2** are often accompanied with the formation of a colourless and odourless gas that can only be CO_2 . Thus **2** contains CO_3^{2-} or HCO_3^- .

Second, there are only 3 dark precipitates that can be formed from the given ions: Ag_2O , Ag_2S , and PbS . This fact, together with the *pH* of the solutions, instantly identifies the cation of **1** as Ag^+ , the cation of **6** as Pb^{2+} , the anion of **4** as OH^- , and the anion of **5** as sulfide or hydrosulfide (confirmed by the distinct smell of the solution).

The choice between the latter two can be made by measuring the *pH* of the solution formed in the reaction of **5** with an excess of **1** or **6**. In the case of **1**, the reaction mixture is strongly acidic. Thus the anion of **5** is HS^- .

The evolution of CO_2 in the reaction with Ag^+ and Pb^{2+} also identifies the anion of **2** as HCO_3^- . (in accord with the moderately basic *pH*)

The reaction of **3** and **4** yields ammonia. **4** is obviously not a solution of NH_3 itself. Thus the cation of **3** is NH_4^+ .

2+4 form either a precipitate or ammonia. The cations of **2** and **4** are Na^+ or K^+ .

2+5 do not form either a precipitate or ammonia. The cation of **5** is an alkali metal.

3 is the only solution that does not give a precipitate with Ag^+ . Accordingly, it can be ammonium nitrate, fluoride, or perchlorate. But it does give a precipitate with **2**, a hydrocarbonate of Na^+ or K^+ . Thus the anion of **3** is ClO_4^- and the cation of **2** is K^+ . **4** does not give a precipitate with NH_4ClO_4 . The cation of **4** is Na^+ .

5 does not give a precipitate either with NH_4ClO_4 (K^+) or with a mixture of KHCO_3 and NaOH (Li^+). The cation of **5** is **Na⁺**.

7 forms no precipitate or ammonia with NaOH but gives a precipitate with KHCO_3 . **7** cannot be an alkali metal perchlorate because it forms yellow precipitates with **1** and **6**. Thus the cation of **7** is **Ba²⁺** and the anion of **7** is Γ^- .

At room temperature **8** gives a precipitate with OH^- but not with HS^- which means it can only be a salt of a Group 2A metal. Thus the reaction of **8** with BaI_2 is obviously one between Ba^{2+} and the anion of **8**. The latter is very likely SO_4^{2-} but HCO_3^- and H_2PO_4^- are also theoretically possible. The solution of **8** is unchanged upon boiling and gives a white precipitate with Ag^+ . This excludes both HCO_3^- and H_2PO_4^- . Thus the anion of **8** is **SO₄²⁻**. This instantly identifies the cation of **8** as **Mg²⁺**.

6 is a soluble compound of lead. The anion could be CH_3COO^- , NO_2^- , NO_3^- , or ClO_4^- . The slight odour of acetic acid might give a clue. Unlike **1**, the reaction of an excess of **6** with HS^- does not yield a markedly acidic solution which shows that **6** is a salt of a weak acid. If **6** were a nitrite, it would give a yellowish precipitate with Ag^+ . It would also react with NH_4ClO_4 upon heating with the evolution of N_2 (and nitrogen oxides from the reaction with HS^- would also be noticeable). The absence of these reactions indicates that the anion of **6** is **CH₃COO⁻**.

Soluble salts of silver are even less numerous, the only choices are NO_3^- , F^- , and ClO_4^- . The anion can be examined if one removes the silver ions from the solution of **1** with an excess of NaOH . The Ag_2O precipitate quickly separates from the solution which can be easily poured off. This solution, containing the anion of **1**, does not give a precipitate with BaI_2 which rules out F^- . The solubility of KClO_4 is quite significant; therefore the absence of a precipitate with KHCO_3 is inconclusive. The anion of **1** is therefore either **NO₃⁻** or **ClO₄⁻**.